

Article number: 03014006

Description: Fluro Rod End GARSW 6
Housing stainless steel

Measures

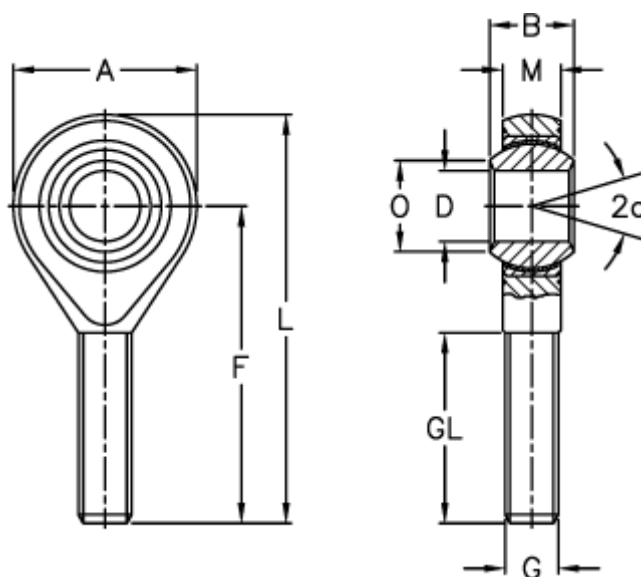

A	= 20	L	= 46
a (degrees)	= 13	M	= 6.75
B	= 9	O	= 8.9
D	= 6	Permissible rpm	= 530
Dynamic load C (kN)	= 9.3	Static load C0 (kN)	= 8.8
F	= 36	Weight (g)	= 20
g	= M6		
GL	= 22		